

www.kobalkonstrukcije.si



KOBAL

KONSTRUKCIJE d.o.o

Izdelava AGRO-opreme in KOVINSKIH KONSTRUKCIJ



Tacenska cesta 90, 1000-Ljubljana



+386 / 01 361 80 24

+386 / 41 613 411 Brane Kobal

+386 / 31 772 529 Matic Kobal



info@kobalkonstrukcije.si

www.kobalkonstrukcije.si



AGRO-oprema

- GOVEDOREJA
- KONJEREJA
- TRANSPORTERJI ZA GNOJ (sistem KRT, STRUGALA, KONZOLE...)
- PAŠNE JASLI / KRMILNIKI (za govedo in konje)
- OBJEMKE
- NAPAVALNIKI ZA GOVEDO „KOBAL“
- VERIGE IN PRIVEZI ZA GOVEDO

MONTAŽNE KOVINSKE KONSTRUKCIJE

- GOVEJI HLEVI
- STROJNE LOPE
- HALE, SKLADIŠČA
- NADSTREŠKI

Smo družinsko podjetje, z dolgoletno tradicijo v proizvodnji AGRO-opreme in kovinskih konstrukcij. Na trgu smo prisotni že več kot 50 let in danes z delom nadaljuje že tretja generacija.

S kakovostnim in zanesljivim delom smo si skozi leta ustvarili zaupanje strank v Sloveniji in tudi zunaj nje.

Neprestano sledimo trendom v kmetijstvu, zato vam omogočamo napredno in najsodobnejšo AGRO-opremo za vaš hlev.



ZANESLJIVOST



KAKOVOST



ZNANJE in
IZKUŠNJE



3D IZKRIS VAŠEGA HLEVA



Prava rešitev za vas !



Švedska KLASIČNA krmilna pregrada „KOBAL“

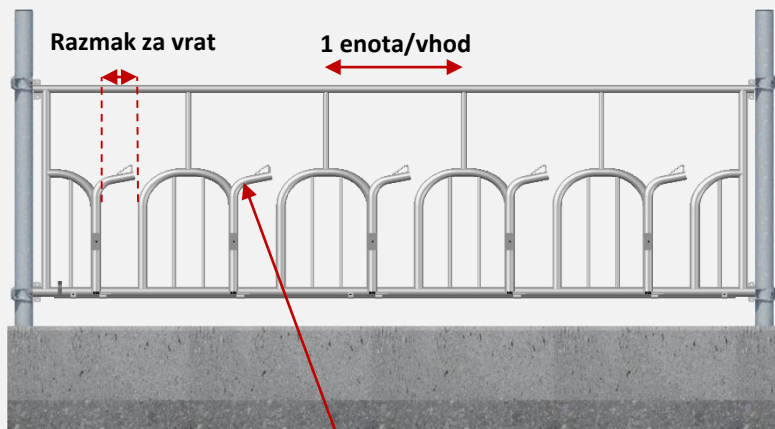

Zapiralo (zaprto)

- Kakovostno vroče pocinkana pregrada
- Masivna konstrukcija (primerna za govedo z rogovi)
- Enostaven način odpiranja (možno tudi brez zapiral)
- Razmak za vrat je odvisen od velikosti goveda
- Enostavna montaža na že obstoječe stebre
- Dolžine krmilnih pregrad po želji

Švedska POLOVIČNA krmilna pregrada „KOBAL“



- Kakovostno vroče pocinkana pregrada
- Masivna konstrukcija (primerna za govedo z rogovi)
- Enostaven način odpiranja (možno tudi brez zapiral)
- Razmak za vrat je odvisen od velikosti goveda
- Govedo v različnih težah in velikostih (od 400 kg naprej)
- Enostavna montaža na že obstoječe stebre
- Dolžine krmilnih pregrad po želji

PALISADNA krmilna pregrada

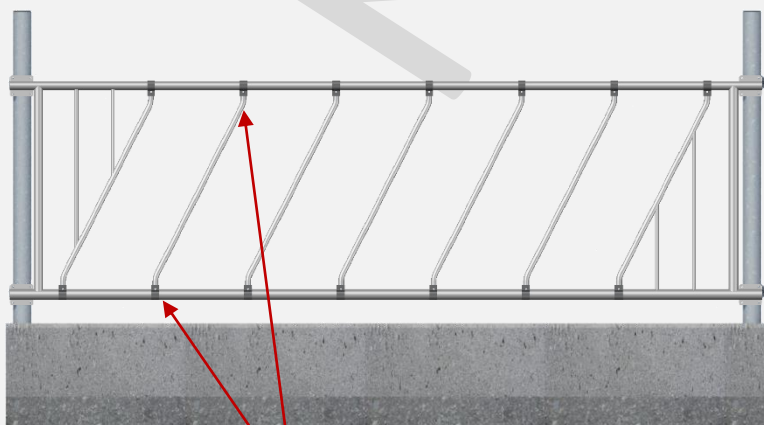

Možnost samonastavitve širine za vrat

- Kakovostno vroče pocinkana pregrada
- Masivna konstrukcija
- Primerna za govedo brez rogovi
- Razmak za vrat je odvisen od velikosti goveda (Možna samonastavitve)
- Enostavna montaža na že obstoječe stebre
- Dolžine krmilnih pregrad po želji



Krmilna pregrada – Serena



- Kakovostno vroče pocinkana pregrada
- Masivna konstrukcija
- Primerna za govedo brez rogov
- Enostaven način odpiranja
- Možnost samonastavitve razmaka za vrat goveda
- Enostavna montaža na že obstoječe stebre
- Dolžine krmilnih pregrad po želji



Krmilna pregrada – Liberty

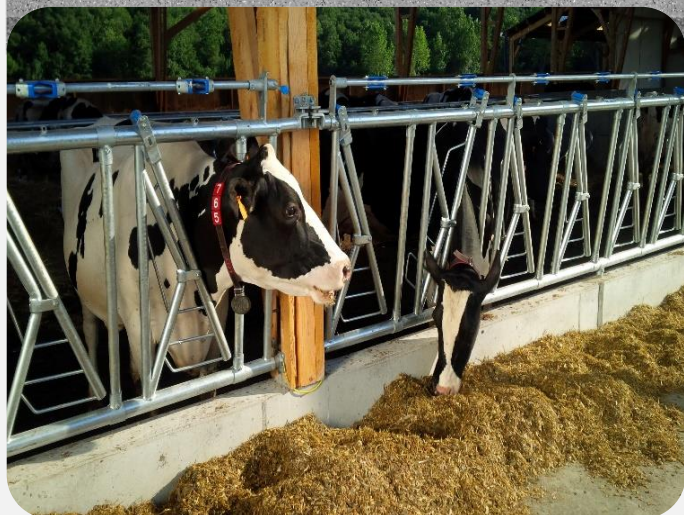

- Kakovostno vroče pocinkana pregrada
- Masivna konstrukcija
- Primerna za govedo brez rogov
- Enostaven način odpiranja
- Dovršena krmilna pregrada
- Možnost samonastavitve razmaka za vrat goveda
- Enostavna montaža na že obstoječe stebre
- Dolžine krmilnih pregrad po želji



Stari trg pri Ložu / Babno polje



Straža / Novo mesto



Zamušani / Ptuj



Ledine / Idrija



Gradišče / Šmartno pri Litiji



Gradišče / Šmarno pri Litiji



Rupa / Kranj



Gorjuša / Domžale



Ledine / Idrija



Vodice



Krmilna pregrada – klasični A-sistem

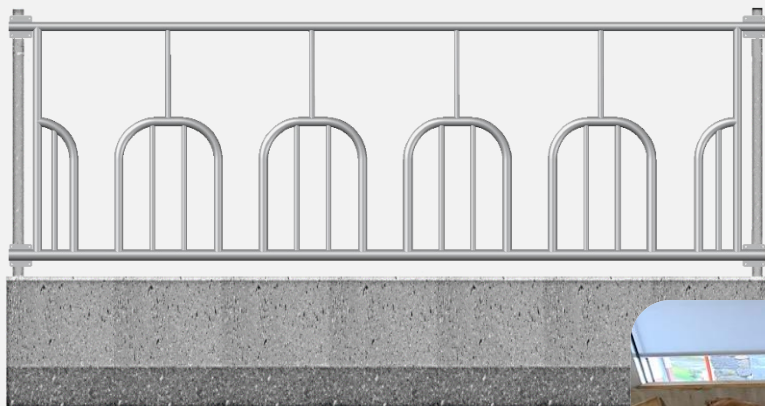

- Kakovostno vroče pocinkana pregrada
- Masivna konstrukcija
- Primerna za govedo z ali brez rogov
- Enostavna montaža na že obstoječe stebre
- Dolžine krmilnih pregrad po želji



MOŽNOST TUDI Z ZAPIRALKAMI!!!

Krmilna pregrada – podaljšan A-sistem

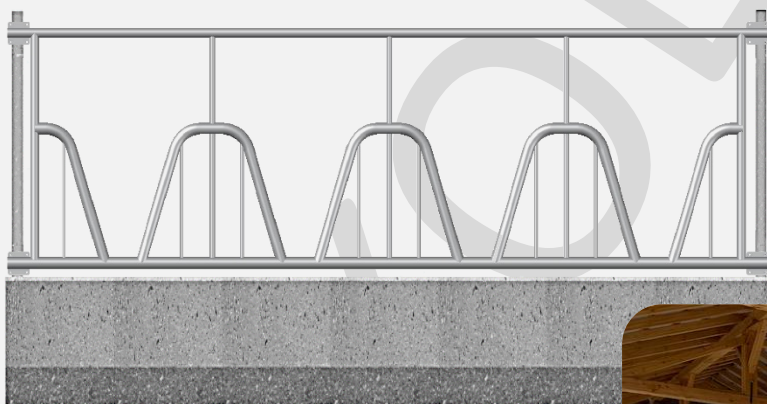

- Kakovostno vroče pocinkana pregrada
- Masivna konstrukcija
- Primerna za govedo z ali brez rogov
- Enostavna montaža na že obstoječe stebre
- Dolžine krmilnih pregrad po želji



ZAPIRALKE NISO MOŽNE!!



Krmilna pregrada za teleta – z zapirali

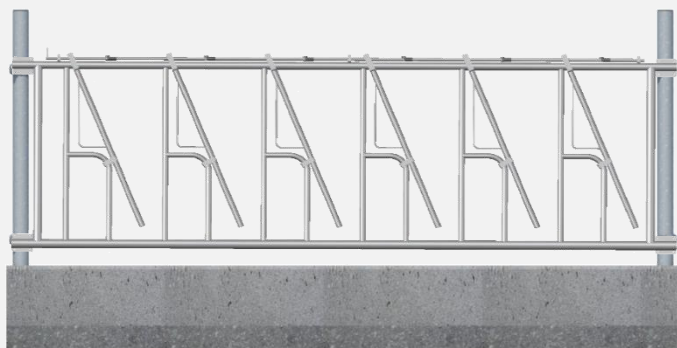

- Kakovostno vroče pocinkana pregrada
- Konstrukcija prilagojena teži telet
- Enostaven način odpiranja
- Teletom prijazna krmilna pregrada
- Možnost samonastavitev razmaka za vrat telet
- Enostavna montaža na že obstoječe stebre
- Dolžine krmilnih pregrad po želji

Krmilna pregrada za teleta – klasični A-sistem

- Kakovostno vroče pocinkana pregrada
- Konstrukcija prilagojena teži telet
- Enostaven način odpiranja
- Teletom prijazna krmilna pregrada
- Možnost samonastavitev razmaka za vrat telet
- Enostavna montaža na že obstoječe stebre
- Dolžine krmilnih pregrad po želji

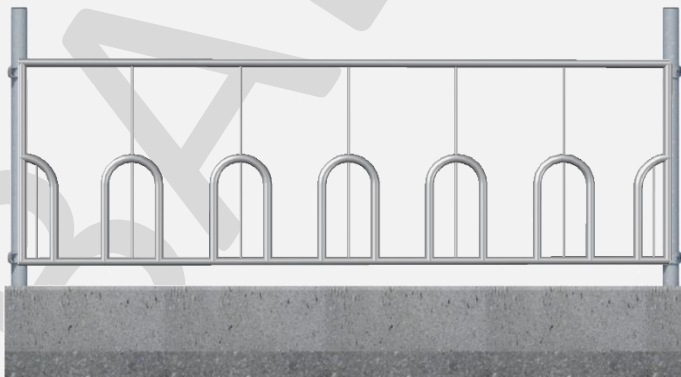

Krmilna pregrada za teleta – klasični A-sistem



Boks za teleta-PETORČEK



dodatno

1. Posoda za pitje + sesek



2. Ovratnica + veriga za teleta



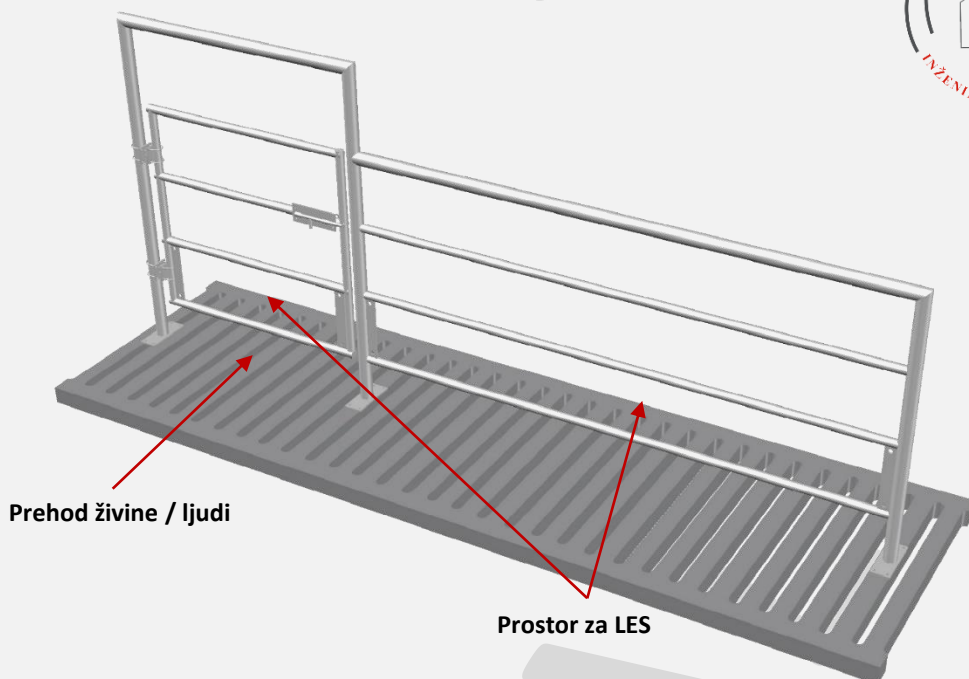

Vmesna pregrada 4-cevna



Vmesna pregrada 5-cevna



- Vmesne pregrade so namenjene ločevanju prostorov znotraj hleva
- Bolj pregledno in nazorno ločevanje živine po teži
- Masivna vroče pocinkana pregrada
- Enostavna in hitra montaža
- Postavitev vmesnih pregrad je lahko montažna ali betonska
- Dolžine vmesnih pregrad so po naročilu oz. želji stranke



TELESKOP vrata (brez napajalnika)

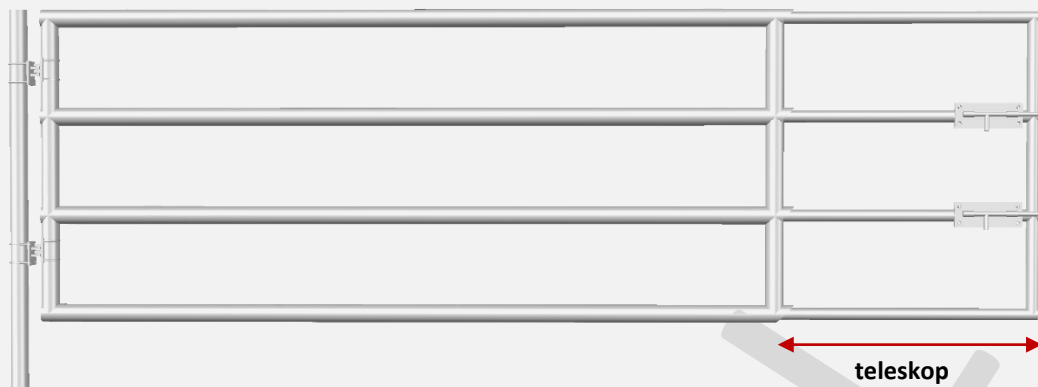

Vsa teleskopska vrata so izdelana po željenih merah oz. naročilu

TELESKOP vrata (z napajalnikom)



Vsa teleskopska vrata so izdelana po željenih merah oz. naročilu





Visoko stojišče

Stojišče z napajalnikom v jasliah



dodatno

Ulitki so povezovalni elementi pri visokih navezah, za privez goveda na stojišče.



T-kos (6/4" na 2")
Povezava med zgornjo cevjo in stojiščem



Segment za verigo
Povezava med zgornjo cevjo in verigo

Nizko stojišče – D TIP

Stojišče z napajalnikom v stojišču

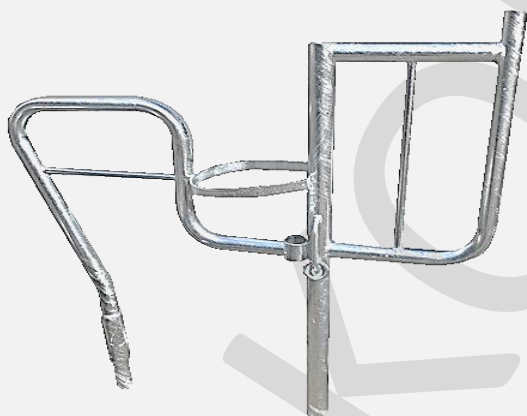

Stojišče z napajalnikom v jasliah

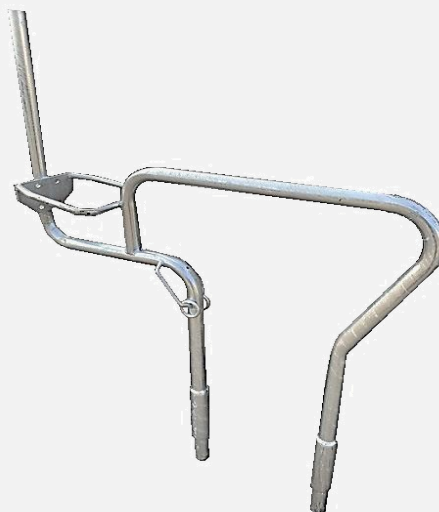

dodatno

1. Napajalnik „KOBAL“



2. Objemka žična zanka- odprta 48 x 33 (6/4" na 1")



3. Ovratnica + veriga za govedo



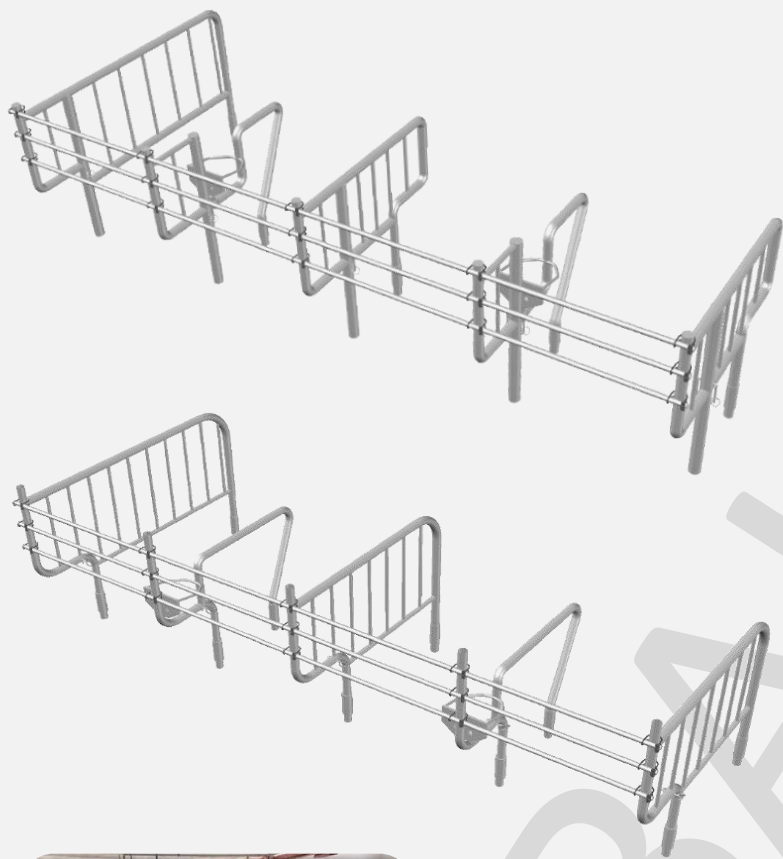

D TIP stojišče z napajalnikom v stojišču

- Vroče pocinkana kovinska konstrukcija
- Vezano govedo
- Primerno za vse vrste goveda
- Primerno za manjše kot tudi večje hleve

D TIP stojišče z napajalnikom v jasliah

- Vroče pocinkana kovinska konstrukcija
- Vezano govedo
- Primerno za vse vrste goveda
- Primerno za manjše kot tudi večje hleve



LEŽALNI LOKI



2022

EURO-2050

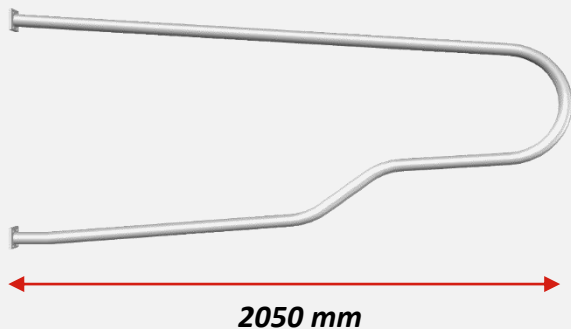

EURO-1900

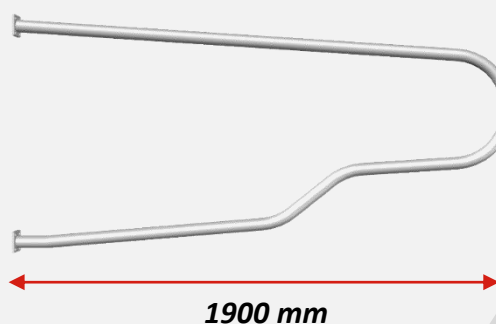

NA PLOŠČI

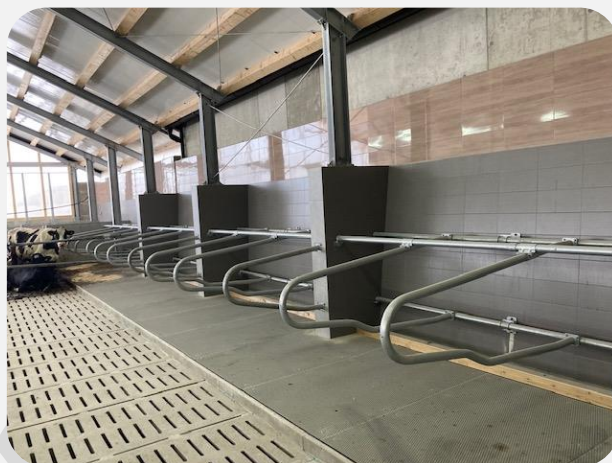
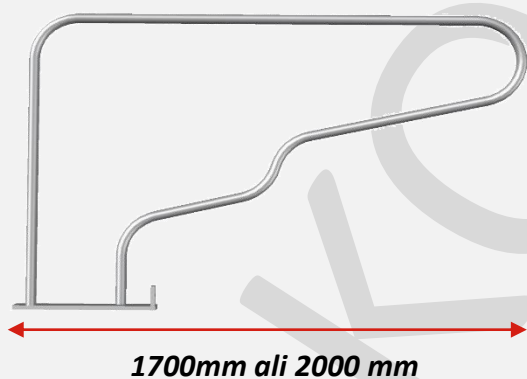

dodatno

1. KAPA CEVNA 2" na 2"
(Ø 60 x 60)



2. KAPA CEVNA 2" na 6/4"
(Ø 60 x 48)



3. U-objemka z matico 2"
(Ø 60)





SISTEM KRT

OHIŠJE – cevni izbruh

(Gnojišče NI neposredno ob hlevu)

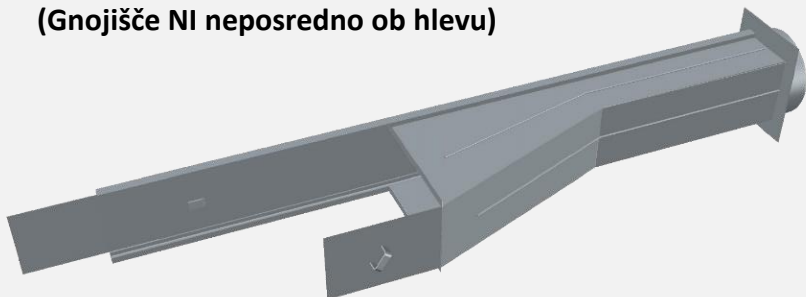

OHIŠJE – direktni izbruh

(Gnojišče JE neposredno ob hlevu)

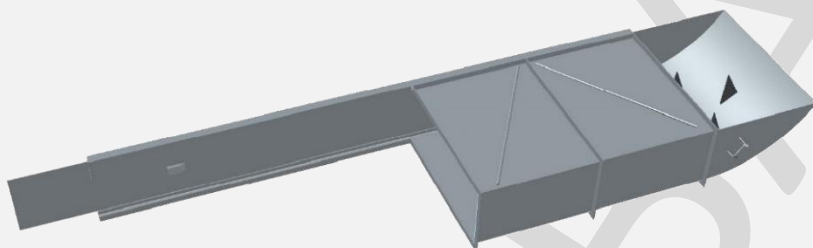

Sistem KRT je sistem, ki nam omogoča lažji in hitrejši transport gnoja iz vašega hleva do gnojišča.

Prednosti Sistema KRT:

- Hitrejši in lažji transport gnoja
- Minimalni napor
- Minimalno oskrbovanje
- Prijazno živini



Agregat z elek. motorjem





SISTEM KRT

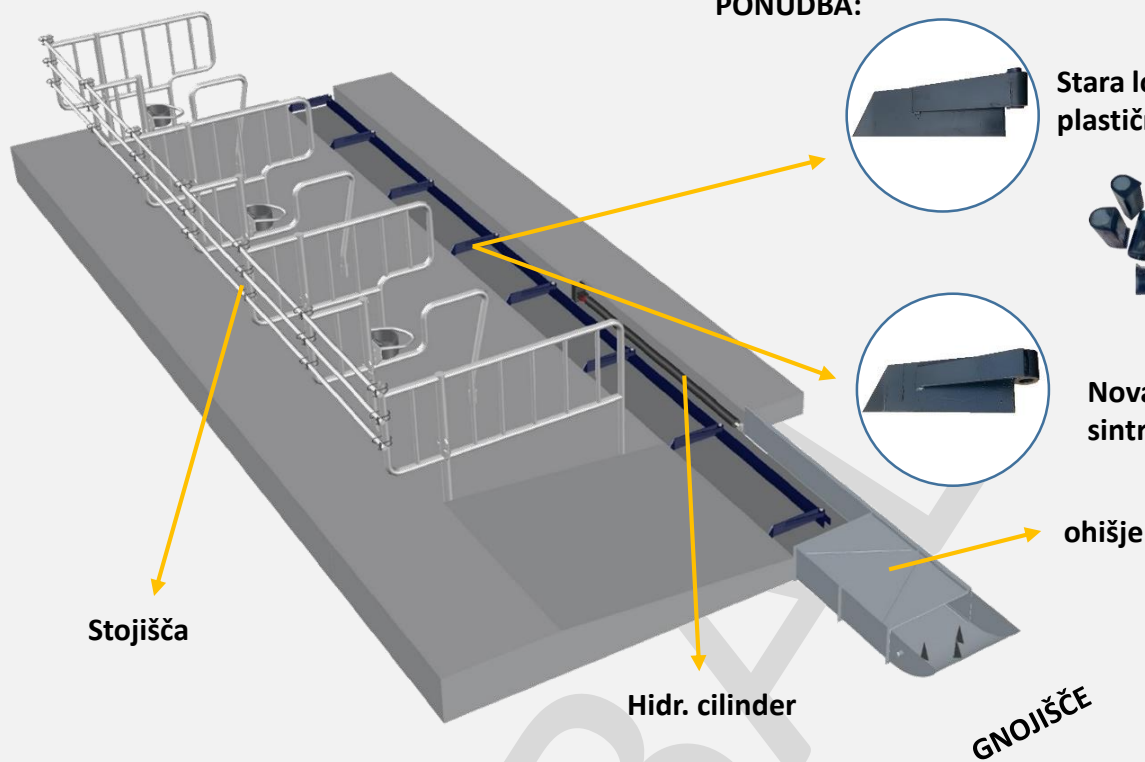

PONUDBA:



Stara lopatica +
plastični vložek



Nova lopatica +
sintrani vložek

ohišje

Stojišča

Hidr. cilindar

GNOJIŠČE

STRUGALO IN KONZOLA

STRUGALO (prosta reja)

- Čiščenje večjih hlevov z večjim številom goveda
- Avtomatsko ugašanje sistema
- Hidravlični potisk



KONZOLA

- Površinsko ustvarjanje gnoja
- Vkllop/izklop
- Elektro-motor (konzola)



KVADRATNA IZVEDBA

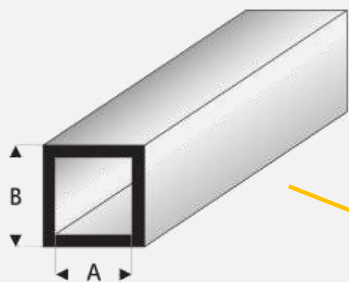

D Š V

90cm x 80cm x 5/4cm

100cm x 80cm x 5/4cm

110cm x 80cm x 5/4cm

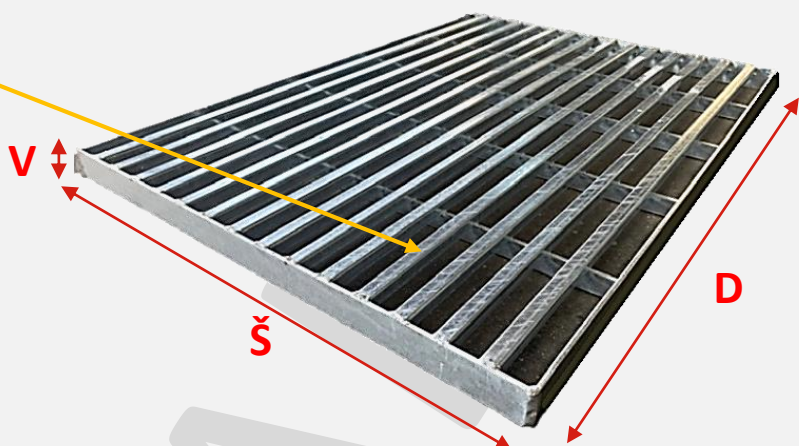

Možne pa so tudi rešetke po naročilu.

T- IZVEDBA

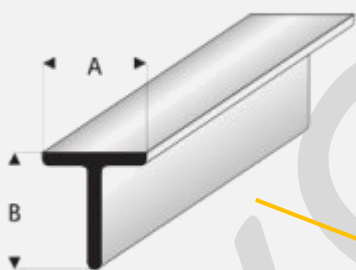

D Š V

90cm x 80cm x 5/4cm

100cm x 80cm x 5/4cm

110cm x 80cm x 5/4cm

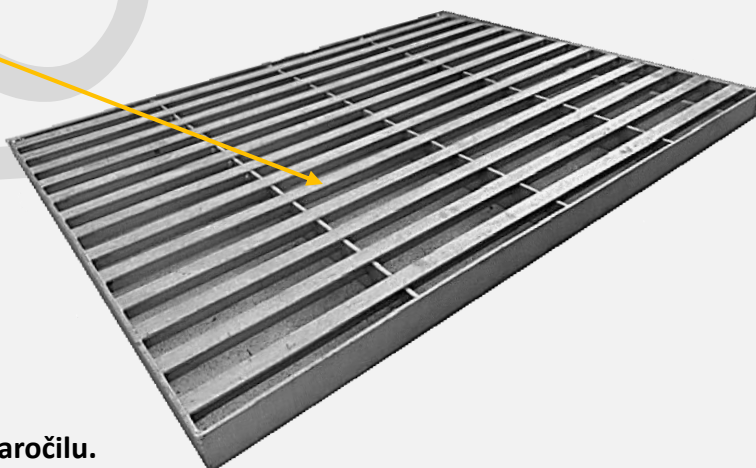

Možne pa so tudi rešetke po naročilu.



Pašne jaslji – KLASIČNE
(12 in 14 glav)

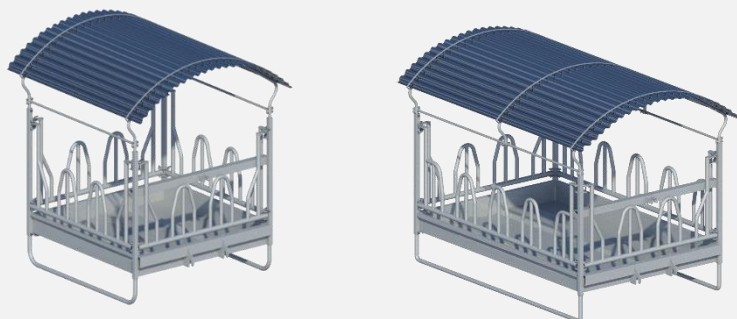

Pašne jaslji – Z ZAPORNICAMI
(12 in 14 glav)



Pašne jaslji – ZA KONJE
(12 in 14 glav)

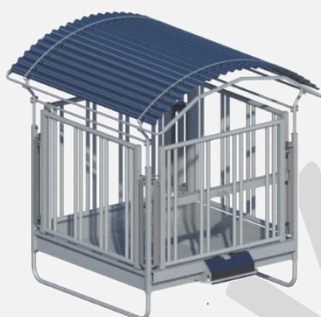

Pašne jaslji – KLASIČNE ALI Z ZAPORNICAMI NA KOLESIH
(14 in 22 glav)

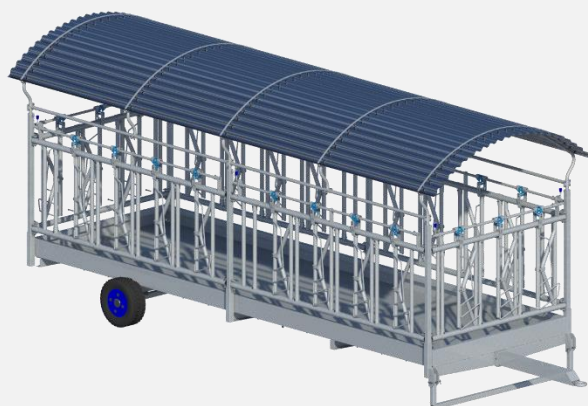



PAŠNE PREGRADE

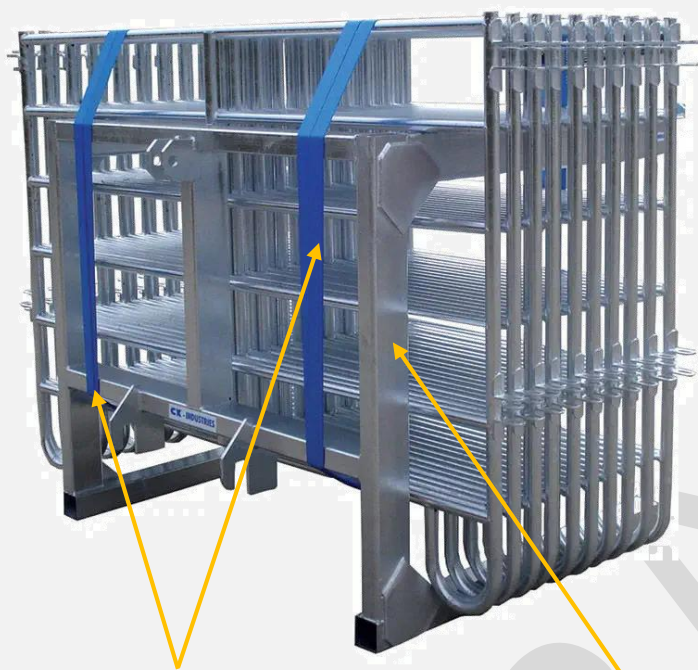

**Varnostna pasova
(lažji transport)**

Nosilec pregrad (max. 20kom)

- Kakovostno vroče pocinkana pašna pregrada
- Različne dimenzije pregrad
- Hitro in enostavno postavljanje pregrad
- Med pregradami so možna tudi vrata za prehod ljudi
- Obvezna postavitev na raven teren

DIMENZIJE:

-	2.00m	x	1.60m	26kg
-	2.50m	x	1.60m	33kg
-	3.00m	x	1.60m	45kg

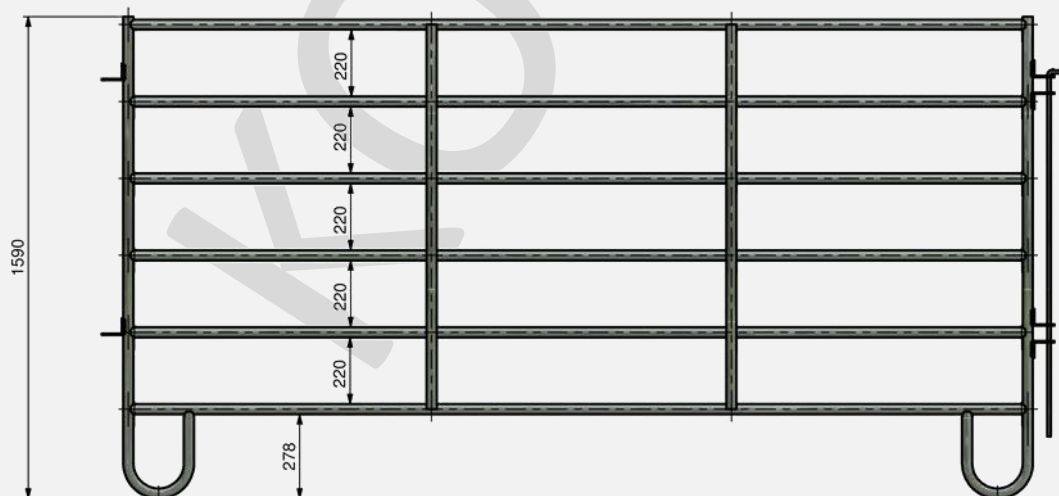

Primerno tudi za vse KMETIJSKE ZADRUGE, TEHNIČNE TRGOVINE in AGRO TRGOVINE



NAPAJALNIK „KOBAL“

Napajalnik **KOBAL** (Al), je namenjen za pitje goveda. Omogoča prijazno in hitro pitje, ter hkrati predstavlja lepo in kakovostno obliko.



dodatno



Original ventil
KOBAL



Palčka z malim jezičkom

AGRO-OBJEMKE

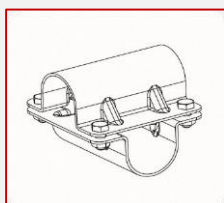

KAPA CEVNA 2" na 2" (60mm x 60mm)
Komplet (2 polovici)
KAPA CEVNA 6/4" na 6/4"
(48mm x 48mm)
Komplet (2 polovici)

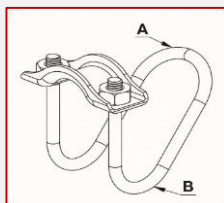

ŽIČNA ZANKA / ODPRTA
6/4" na 1" (48mm x 33mm)
Kos
Namen: Goveja stojišča /
sprednje cevi

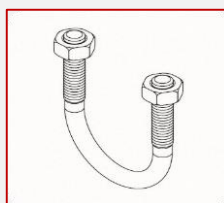

U-OBJEMKA 2" (60mm)
Kos (matice SO vključene)
U-OBJEMKA 6/4" (48mm)
Kos (matice SO vključene)

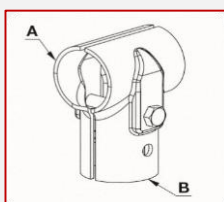

T-objemka KLASIČNA
(2 polovici)

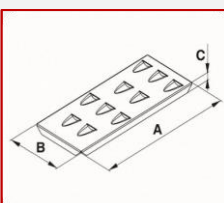

ODTOČNA REŠETKA
(500 x 200 x 28)
Odtok gnojnice

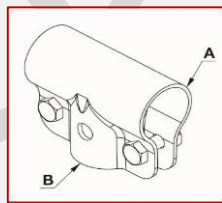

T-OBJEMKA RAZŠIRJENA

Od 1" cevi (33mm) –
do 2" cevi (60mm)

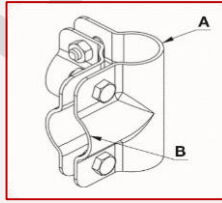

T-OBJEMKA KOTNA
(tri cevna)

Od 1" cevi (33mm) –
do 2" cevi (60mm)

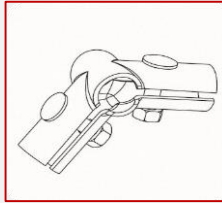

T-OBJEMKA SLEMENSKA

Od 3/4" cevi (27mm) –
do 5/4" cevi (42mm)

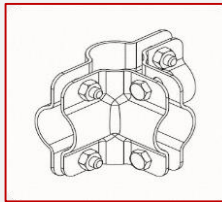

T-OBJEMKA KOTNA
(štiri cevna)

Od 3/4" cevi (27mm) –
do 2" cevi (60mm)

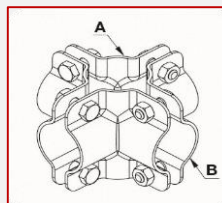

T-OBJEMKA KRIŽNA

Od 3/4" cevi (27mm) –
do 2" cevi (60mm)



KONJI

Izdelava konjskih boksov je naša specialnost že vrsto let. Poleg kakovostnega vroče pocinkanega ogrodja/konstrukcije, vam po želji nudimo tudi polnilo iz masivnega lesa.

Konjski boks je sestavljen iz:

- **Sprednja/čelna stran z vrati**
- **Ena/dve stranski steni, ki ločujeta bokse med seboj**

